

Operation Manual

Horizontal Infrared Toaster

IRT-SB-NA-1PS

IRT-SB-NA-3PS

Product Identification

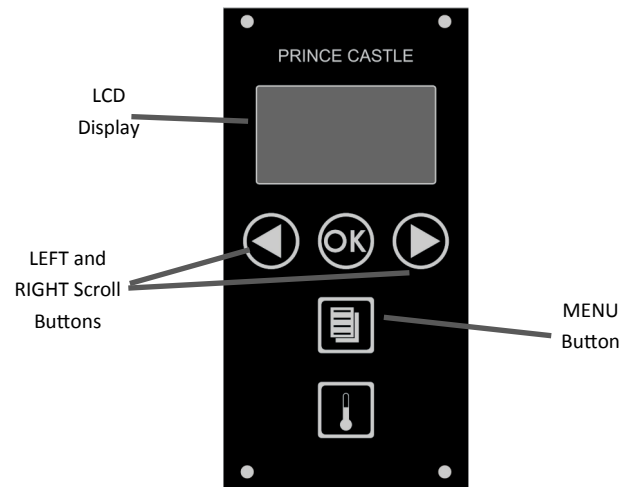
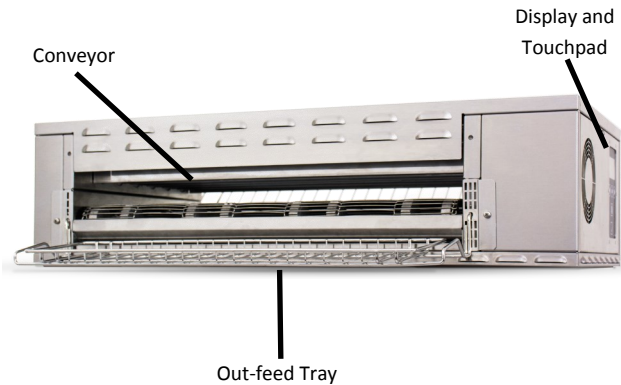

LIMITED WARRANTY

This product is warranted to be free from defects in material and/or workmanship for a period of two (2) years from date of original installation, not to exceed 30 months from date of shipment from our factory. Any part or component which proves to be faulty in material and/or workmanship within the warranty period will be replaced or repaired (at the option of Prince Castle, Inc.) without cost to the customer for parts or labor.

This warranty is subject to the following exceptions/conditions:

- Use of any non-genuine Prince Castle parts voids this warranty and all work must be performed by an authorized Prince Castle Service Agent.
- All labor shall be performed during regular work hours. Overtime premium will not be covered.
- Travel charges are limited to 200 kilometers (100 miles) round trip, 2 hours travel time, one trip per repair.
- Damage caused by carelessness, neglect, and/or abuse (e.g., using wrong current, dropping, tampering with or altering electrical components, or improper cleaning) is not covered.
- Equipment damaged in shipment, by fire, flood or an act of God is not covered.
- Damage to non-stick coated surfaces is not covered by this warranty.

TABLE OF CONTENTS

Product Identification.....	Page 1
Warranty Statement.....	Page 1
Table of Contents.....	Page 1
Electrical Specifications.....	Page 2
Safe Service Practices.....	Page 2
Serial Number Matrix.....	Page 2
Installation.....	Page 3
Operation.....	Page 4
Cleaning.....	Page 6
Display Menu Options.....	Page 7
Management Programming.....	Page 9
Exploded View and Parts List.....	Page 12
Troubleshooting Guide.....	Page 15



355 East Kehoe Blvd. • Carol Stream, IL 60188 USA
Telephone: 630-462-8800 • Toll Free: 1-800-PCASTLE
Fax: 630-462-1460 • www.princecastle.com

Horizontal Infrared Toaster

IRT-SB-NA-1PS

IRT-SB-NA-3PS



Electrical Specifications

IRT-SB-NA-1PS 200-240VAC, 50/60 Hz, 1 Ph.

IRT-SB-NA-3PS 200-240VAC, 50/60 Hz, 1 Ph.

Disconnect Power

 **WARNING**

Failure to turn off the unit before servicing could result in severe bodily injury or death. Switch the On/Off switch to the Off position before servicing.

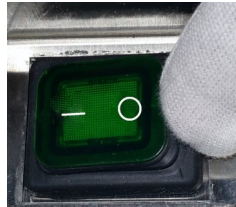

Important

Prince Castle reserves the right to change specifications and product design without notice. Such revisions do not entitle the buyer to corresponding changes, improvements, additions, or replacements for previously purchased equipment.

Safe Service Practices

 **WARNING**

Indicates information important to the proper operation of the unit. Failure to observe may result in damage to the equipment and/or severe bodily injury or death.

 **CAUTION**

Indicates information important to the operation of the unit. Failure to observe may result in damage to the equipment.

GENERAL

This appliance is designed for toasting bread products in a commercial McDonalds kitchen. The dimensions of the bread products as defined by McDonalds.

 **CAUTION**

Do not hose down or use a water jet on the unit. Keep the unit away from running water. Disconnect power cord before performing any cleaning or maintenance.

 **CAUTION**

Equipment must be elevated from the floor at all times during cleaning and operation.

Serial Number Matrix

The manufacture date is encoded in the unit's serial number. The service bench installation date (used to determine warranty coverage) is considered to be the end of the following month. For example:

Serial Number: FJ0000458
 Manufacture Date: June 2014
 Service Bench Installation Date: July 31, 2014

		SERIAL NUMBER MATRIX								
		2014	2015	2016	2017	2018	2019	2020	2021	2022
		J	K	L	M	N	O	P	Q	R
January	A	AJ	AK	AL	AM	AN	AO	AP	AQ	AR
February	B	BJ	BK	BL	BM	BN	BO	BP	BQ	BR
March	C	CJ	CK	CL	CM	CN	CO	CP	CQ	CR
April	D	DJ	DK	DL	DM	DN	DO	DP	DQ	DR
May	E	EJ	EK	EL	EM	EN	EO	EP	EQ	ER
June	F	FJ	FK	FL	FM	FN	FO	FP	FQ	FR
July	G	GJ	GK	GL	GM	GN	GO	GP	GQ	GR
August	H	HJ	HK	HL	HM	HN	HO	HP	HQ	HR
September	J	JJ	JK	JL	JM	JN	JO	JP	JQ	JR
October	K	KJ	KK	KL	KM	KN	KO	KP	KQ	KR
November	L	LJ	LK	LL	LM	LN	LO	LP	LQ	LR
December	M	MJ	MK	ML	MM	MN	MO	MP	MQ	MR

Horizontal Infrared Toaster

IRT-SB-NA-1PS

IRT-SB-NA-3PS



Installation

1 Unpack and Inspect. Remove the unit from the carton and inspect for signs of damage. If there is damage to the unit:

- Notify the carrier within 24 hours of delivery
- Save carton and packaging materials for inspection purposes.
- Contact your local dealer.

2 Verify parts. Verify that all parts have been received. When replacing parts use Prince Castle parts only.

- Horizontal Infrared Toaster
- Out-Feed Tray
- In Feed Rack
- Crumb Tray (Already installed)

3 Place toaster on a sturdy surface. Remove blue and/or white protective covering prior to powering on.

 **CAUTION**

Two man lift, unit weight is more than 50 lbs.

4 Follow daily PM procedures.

5 Install In-Feed Rack . Slide the in-feed rack onto 1 hook on each side. Ensure the rack is secure before operating the unit.



Install Out-Feed Tray. Insert the Out-Feed Tray onto one hook on each side. Ensure the rack is secure before operating the unit.



6 Plug unit in. Plug unit into a grounded receptacle with a matching plug configuration.

 **WARNING**

All electrical connections must be in accordance with local electrical codes and any other applicable codes.

If the supply cord is damaged, it must be replaced by the manufacturer, its service agent, or similarly qualified persons in order to avoid hazards.

To prevent an electric shock hazard, this device must be bonded to equipment in close proximity with an equipotential bonding conductor. This device is equipped with grounding lug for this purpose and is marked with the following symbol.



Horizontal Infrared Toaster

IRT-SB-NA-1PS

IRT-SB-NA-3PS



Operation

- 1 Turn unit ON.** Turn the On/Off switch located on back of toaster to ON. The Prince Castle screen will appear in the display for three seconds. (Ensure the conveyor is fully closed)

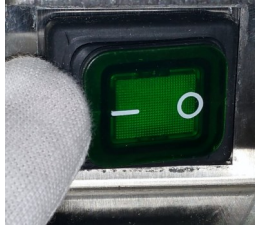

- 2 Wait through Warm-Up.** During Warm-Up, the LCD display will read "WARMING UP". Warm-Up time, is about 15-20 minutes. Bagel Mode will come up by default



- 3 Select product to be toasted** by touching the button until indicator light illuminates. Note: Conveyor belt will change speed based on product selected.

Muffin = White LED
Bagel = Blue LED



- 4**  **WARNING**
BURN/ELECTRICAL SHOCK HAZARD! Toaster can be HOT and can cause severe burns or severe shock. Keep hands and objects out of the toaster unit! Failure to exercise caution may result in serious injury! Turn the unit off, and let it cool down completely before touching or working on internal apparatus.

Watch for Product.
When ready temperature is reached, the LCD display will read "BAGEL" or "MUFFIN" depending on the mode.

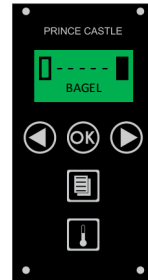

- 5 Feeding in Muffins and Bagels.** Feed product cut side up in the in feed wire racks shown. Rack will allow 6 muffin or 5 bagels across.



- 6 Adjusting Toast.** For lighter toast, press and hold, ~5 seconds, directional key (left) until indicator move towards lighter rectangle. For darker toast, repeat with the direction key (right) that points toward the blackened rectangle.

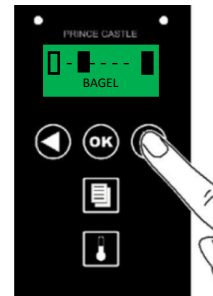

Horizontal Infrared Toaster

IRT-SB-NA-1PS

IRT-SB-NA-3PS

Operation

7

Remove Stuck Product. Retrieve stuck product by first shutting off the power to the unit. **BE CAREFUL NOT TO CONTACT INTERNAL COMPONENTS DURING RETRIEVAL, THEY WILL BE VERY HOT. DO NOT CONTACT HEATING ELEMENTS DURING RETRIEVAL. DAMAGE MAY OCCUR.**



Horizontal Infrared Toaster

IRT-SB-NA-1PS

IRT-SB-NA-3PS

Cleaning



WARNING

BURN/ELECTRICAL SHOCK HAZARD! Toaster can be **HOT** and can cause severe burns or severe shock. **Keep hands and objects out of the toaster unit until fully cool ! Failure to exercise caution may result in serious injury! Turn the unit off, and let it cool down completely before touching or working on internal apparatus.**

1

Remove crumbs from conveyor crumb tray by wiping with a clean, sanitizer-soaked towel. Spray a clean, sanitizer-soaked towel with Heavy Duty Degreaser solution then wipe down the conveyor crumb tray. Rinse crumb tray with a separate clean, sanitizer-soaked towel.



2

Spray a clean, sanitizer-soaked towel with Heavy Duty De-greaser solution then wipe down the in-feed rack. Rinse the in-feed rack with a separate, clean sanitizer soaked towel.



3

Spray a clean, sanitizer-soaked towel with Heavy Duty De-greaser solution then wipe down the out-feed rack. Rinse the out-feed rack with a separate, clean sanitizer-soaked towel.



4

Spray a clean, sanitizer-soaked towel with Heavy Duty De-greaser solution then wipe down the exterior of unit. Rinse the exterior of unit with a separate, clean sanitizer-soaked towel.



Horizontal Infrared Toaster

IRT-SB-NA-1PS

IRT-SB-NA-3PS



Display Menu Options

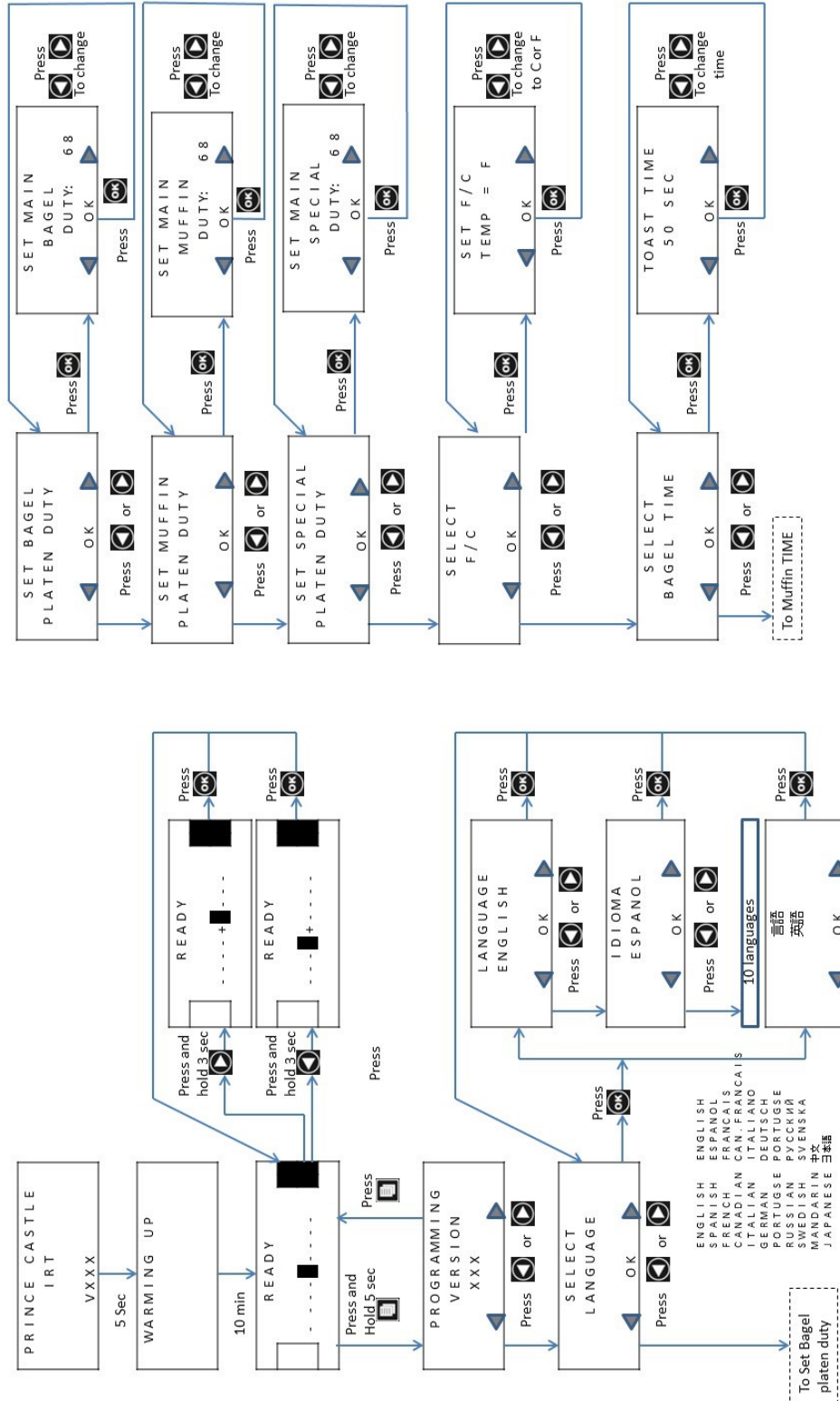

Display Menu Options (Continued...)

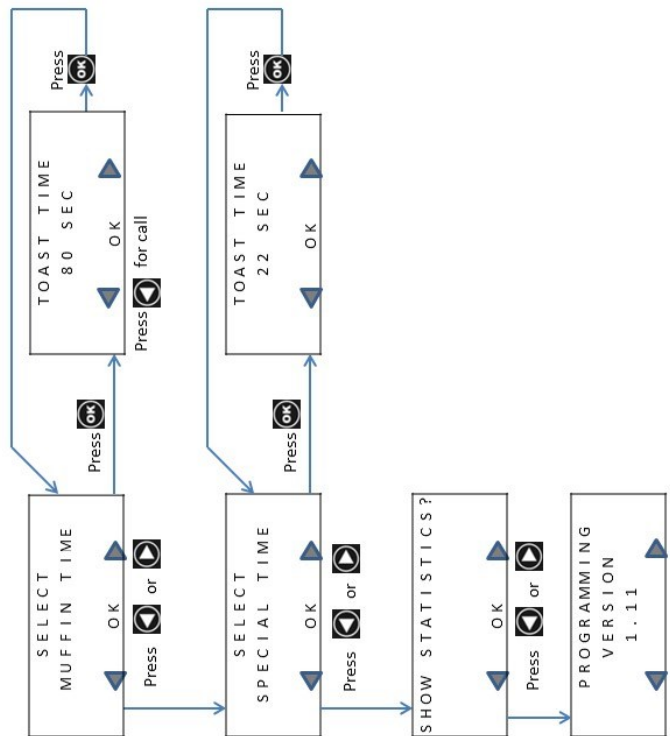

Horizontal Infrared Toaster

IRT-SB-NA-1PS

IRT-SB-NA-3PS



Management Programming

1

To Enter Programming screens
Press and hold the MENU button for 6 seconds. The PROGRAMMING VERSION screen will appear in the LCD display.

From the PROGRAMMING VERSION screen, you may:

Press RIGHT scroll button to advance to the next menu item

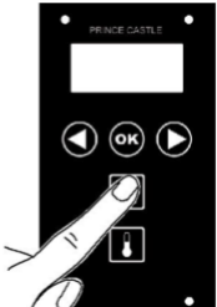

3

To Adjust SET BAGEL PLATEN DUTY from the SELECT LANGUAGE Screen, press the RIGHT scroll button. Press the OK button to enter the programming screen.

A. From the SET BAGEL DUTY screen that appears adjust the set point duty Using the RIGHT and LEFT scroll buttons. Accept the new Duty By pressing OK.

NOTE : To cancel without accepting the new setting, press the MENU logo button to return to the previous screen



2

To Change the LANGUAGE from the PROGRAMMING VERSION

Screen, PRESS the left scroll button.

From the SELECT LANGUAGE Screen, Press OK button

A. From the LANGUAGE screen that appears, use the RIGHT and LEFT scroll buttons. TO select different Language
B. Accept the new language by pressing OK button to return to the SELECT LANGUAGE screen



4

To Adjust SET MUFFIN PLATEN DUTY from the SET BAGEL PLATEN DUTY Screen, press the RIGHT scroll button. Press the OK button to enter the programming screen.

A. From the SET MUFFIN DUTY screen that appears adjust the set point duty Using the RIGHT and LEFT scroll buttons. Accept the new Duty By pressing OK.

NOTE : To cancel without accepting the new setting, press the MENU logo button to return to the previous screen



Horizontal Infrared Toaster

IRT-SB-NA-1PS

IRT-SB-NA-3PS



Management Programming (Continued)

5

To Adjust SET SPECIAL PLATEN DUTY from the SELECT MUFFIN PLATEN DUTY screen, press the RIGHT scroll button. Press the OK button to enter the programming screen.

- A. From the SET SPECIAL DUTY screen that appears adjust the set point duty Using the RIGHT and LEFT scroll buttons. Accept the new Duty By pressing OK.

NOTE : To cancel without accepting the new setting, press the MENU logo button to return to the previous screen

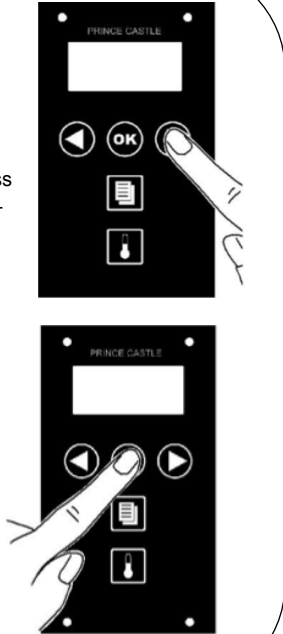

7

To adjust set point BAGEL TOAST TIME from the SELECT F/C screen, press the RIGHT scroll button

From the SELECT BAGEL TOAST TIME Screen, Press OK button

- A. From the SELECT BAGEL TIME that appears, Adjust the set point Time Using the RIGHT and LEFT Scroll buttons. Accept The new toast time by Pressing OK.

NOTE : To cancel without accepting the new setting, press the MENU logo button to return to the previous screen

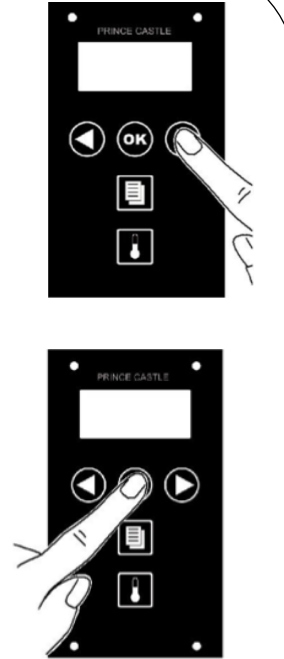

6

To adjust the SELECT F/C From The SELECT SPECIAL PLATEN DUJTY screen, press the RIGHT scroll button.

From the SELECT F/C screen that appears, press the OK button.

- A. From the SET F/C Screen that appears, Use the LEFT and RIGHT scroll buttons to Select TEMP = F (Fahrenheit) or C (Celsius)
- B. Accept the new scale By pressing the OK Button to return to The SELECT F/C screen

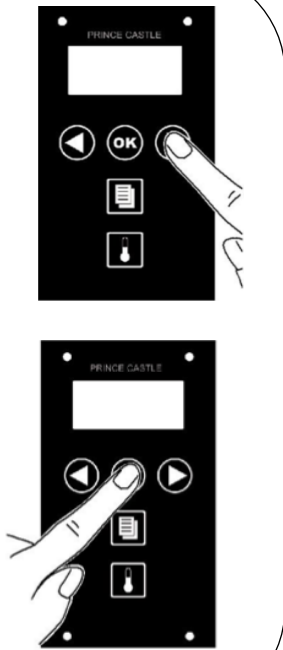

8

To adjust set point MUFFIN TOAST TIME from the BAGEL TOAST TIME screen, press the RIGHT scroll button

From the SELECT MUFFIN TOAST TIME Screen, Press OK button

- A. From the SELECT MUFFIN TIME that appears, Adjust the set point Time Using the RIGHT and LEFT Scroll buttons. Accept The new toast time by Pressing OK.

NOTE : To cancel without accepting the new setting, press the MENU logo button to return to the previous screen

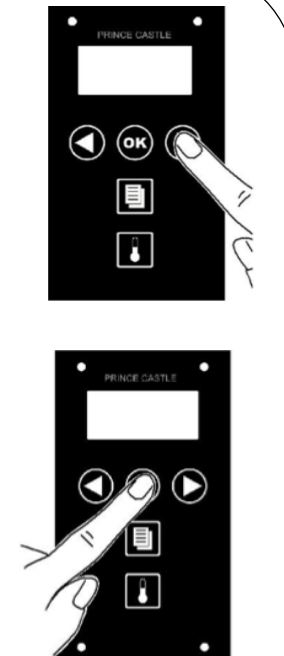

Horizontal Infrared Toaster

IRT-SB-NA-1PS

IRT-SB-NA-3PS



Management Programming (Continued)

9

To adjust set point SPECIAL TOAST TIME from the MUFFIN TOAST TIME screen, press the RIGHT scroll button



From the SELECT SPECIAL TOAST TIME Screen, Press OK button

- A. From the SELECT SPECIAL TIME that appears, Adjust the set point Time Using the RIGHT and LEFT Scroll buttons. Accept The new toast time by Pressing OK.



NOTE : To cancel without accepting the new setting, press the MENU logo button to return to the previous screen

11

To view Service Codes, From the SPECIAL MODE ENABLE / DISABLE screen, press the RIGHT scroll button once.



From the Service Codes screen,

- A. Select OK to check the service codes
- B. Refer to Service codes page to understand the operation of the unit.



10

To Enable or Disable Special Mode, from the SPECIAL TOAST TIME screen, press the RIGHT scroll button once.

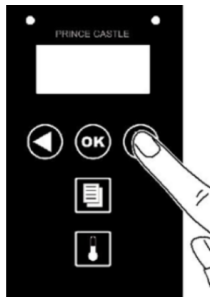

From the SPECIAL MODE ENABLE/DISABLE Screen, Press OK button

- A. From the SPECIAL MODE ENABLE/DISABLE screen that appears, Adjust the toggle Using the RIGHT and LEFT Scroll buttons. Accept The setting by Pressing OK.



NOTE : To cancel without accepting the new setting, press the MENU logo button to return to the previous screen

12

Exit Programming

Press the MENU button from any screen to exit programming mode.



Horizontal Infrared Toaster

IRT-SB-NA-1PS

IRT-SB-NA-3PS



Exploded View and Parts List

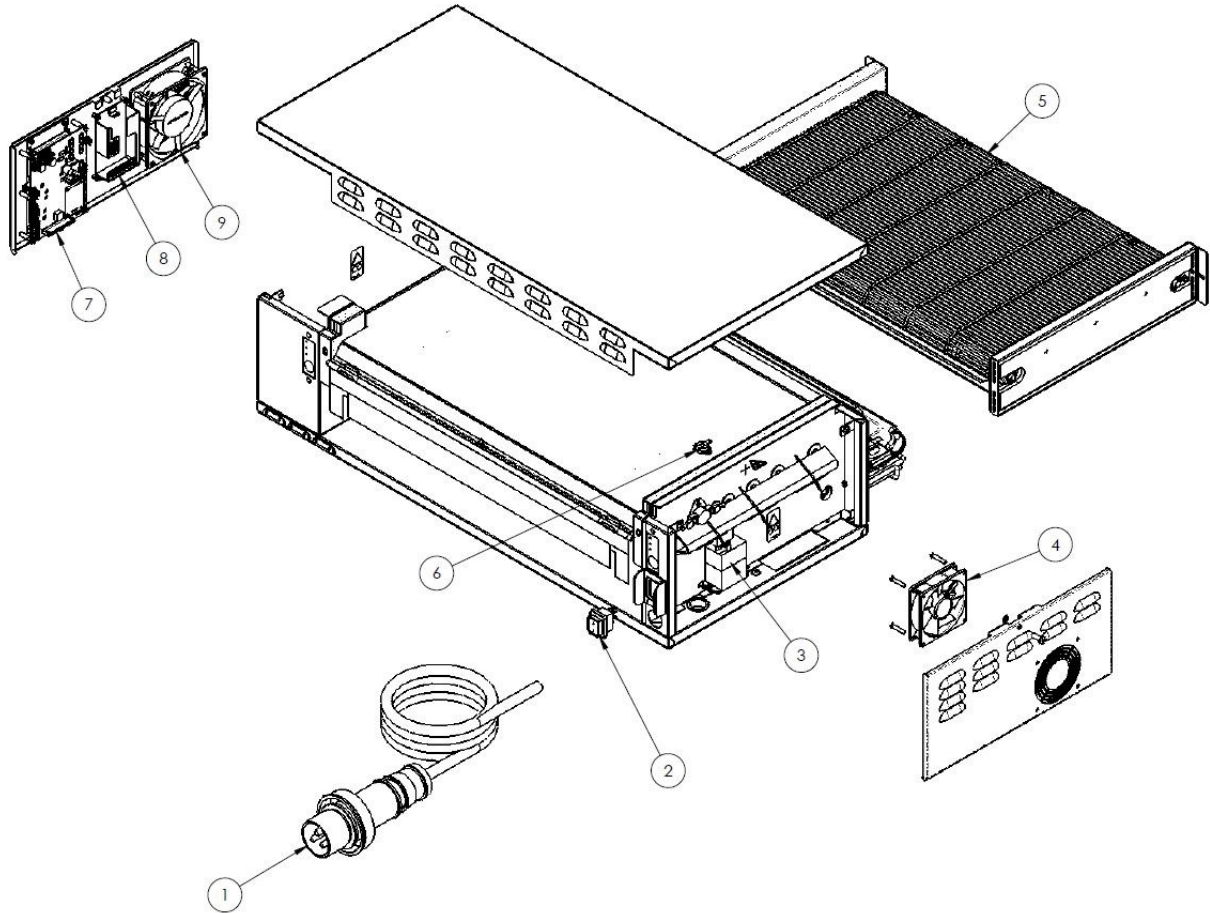

Item #	Part #	Description	Qty
1	72-478S	POWERCORD (FOR IRT-SB-NA-1PS)	1
1	72-471S	POWERCORD (FOR IRT-SB-NA-3PS) NOT SHOWN	1
2	78-233S	SWITCH, ROCKER, DPST, IP65, 16A	1
3	65-067S	RELAY, DPST, 30A, 200/240, 50/60	1
4	86-582S	FAN. 11 A DC 92MM	1
5	353-164S	WIRE BELT	1
6	353-394S	THERMOSTAT, SNAP DISC CONTROL, 120	1
7	353-262IS	PCB, MAIN CONTROLLER	1
8	85-144-24S	PWER SUPPLY, 24VDC 100W	1
9	37814S	MOTOR FAN, 230V	1

Horizontal Infrared Toaster

IRT-SB-NA-1PS

IRT-SB-NA-3PS



Exploded View and Parts List (Continued)

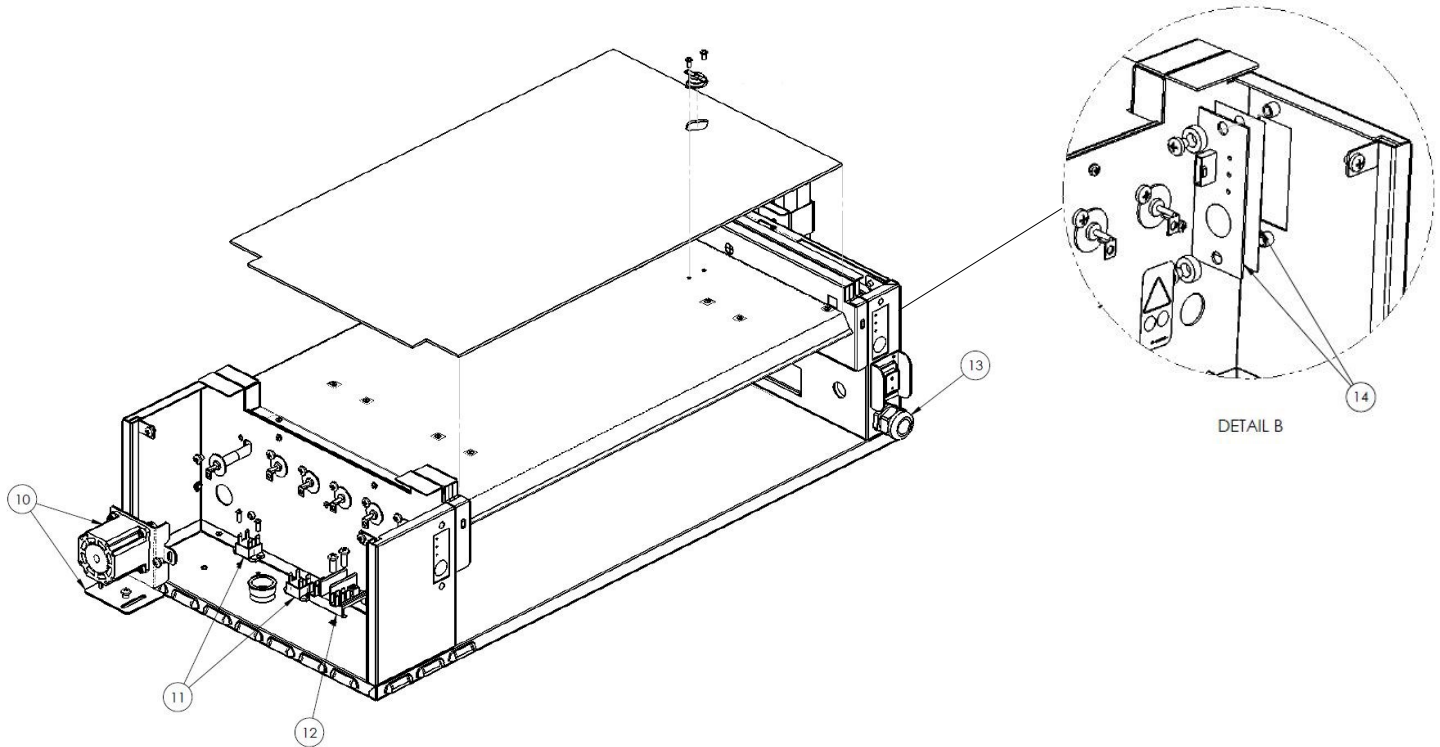

Item #	Part #	Description	Qty
10	353-134S	MOTOR ASSY	1
11	353-313S	RELAY, 4-8VDC, 20A	3
12	77-093S	TERMINAL BLOCK 12POS 2ROW INSULATED	1
13	66-045S	STRAIN RELIEF	1
14	353-426S	PCB, BREAD SELECT BOARD	2

Horizontal Infrared Toaster

IRT-SB-NA-1PS

IRT-SB-NA-3PS



Exploded View and Parts List (Continued)

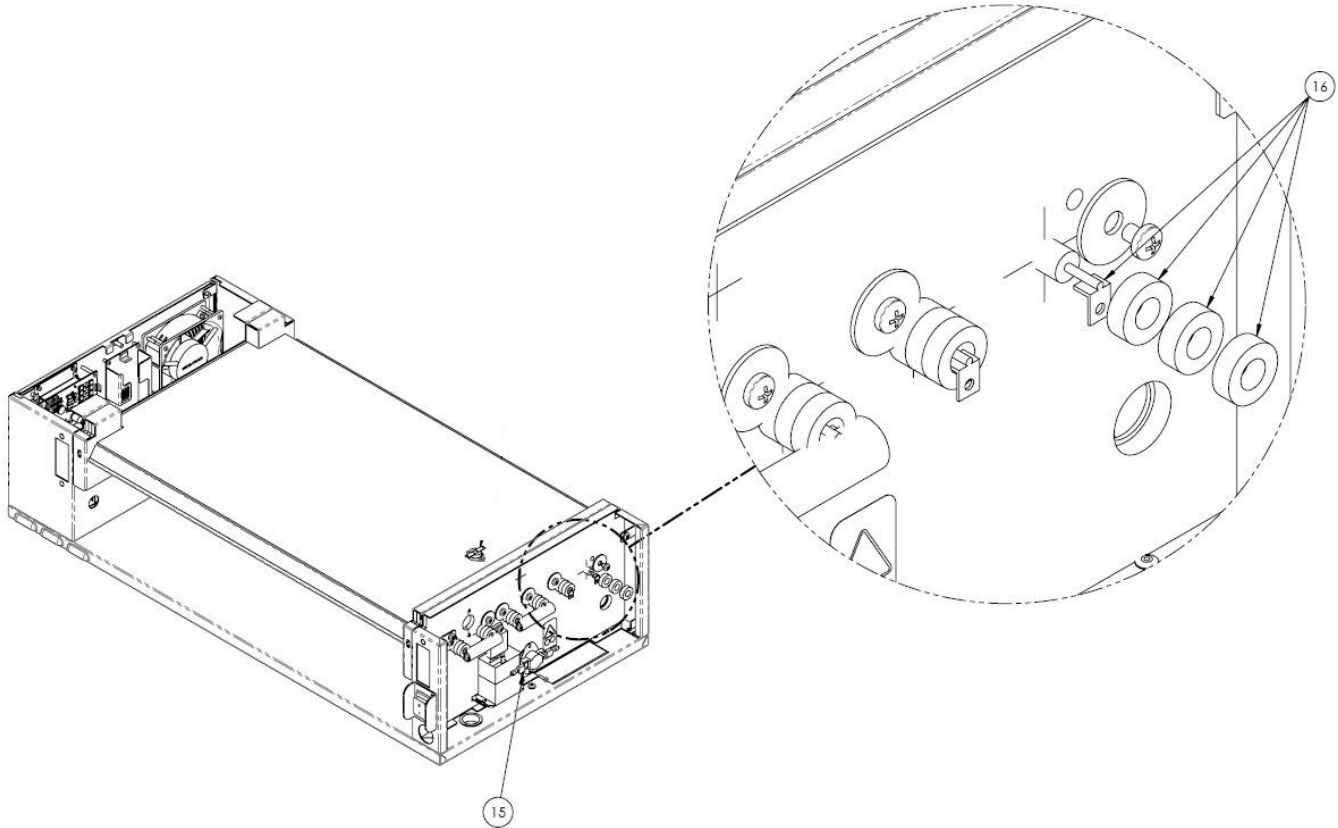

Item #	Part #	Description	Qty
15	353-489S	THERMOSTAT, NC 350F, LIMIT CONTROL, IRT	1
16	353-158S	CALROD	6
17	527-370S	ASSY, MEMBRANE SWITCH & OVERLAY (NOT SHOWN)	1

Horizontal Infrared Toaster

IRT-SB-NA-1PS

IRT-SB-NA-3PS



Troubleshooting Guide

BURN/ELECTRICAL SHOCK HAZARD! Platen is HOT and can cause severe burns or severe shock.
Keep hands and objects out of the toaster unit! Failure to exercise caution may result in serious injury!
Turn the unit off, unplug it and let it cool down completely before touching or working on internal apparatus.

PROBLEM	PROBABLE CAUSE	SOLUTION
Unit will not heat up	No power to unit.	Ensure power cord is connected to
	Inoperable power cord	Call for Service (800) 722-7853
	Loose connection on power switch	Call for Service (800) 722-7853
	Inoperable power switch	Call for Service (800) 722-7853
	High limit switch tripped	Turn off unit for 20 minutes, and re-start. If high limit switch continues to
	Inoperable Heating Element	Call for Service (800) 722-7853
Unit heats up, but the conveyor does not run	Loose motor switch connection.	Call for Service (800) 722-7853
	Loose Conveyor Shaft Drive Collar	Call for Service (800) 722-7853
	Inoperable motor.	Call for Service (800) 722-7853
Unit does not respond to programming.	User interface Malfunction	Call for Service (800) 722-7853
Product under-or over-done.	Check recommended toast time. See	See Programming Guide
	Check Power Settings	See Programming Guide