

# Operation Manual

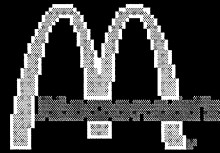

Universal Rapid Toaster  
340-URTG2L

## Product Identification

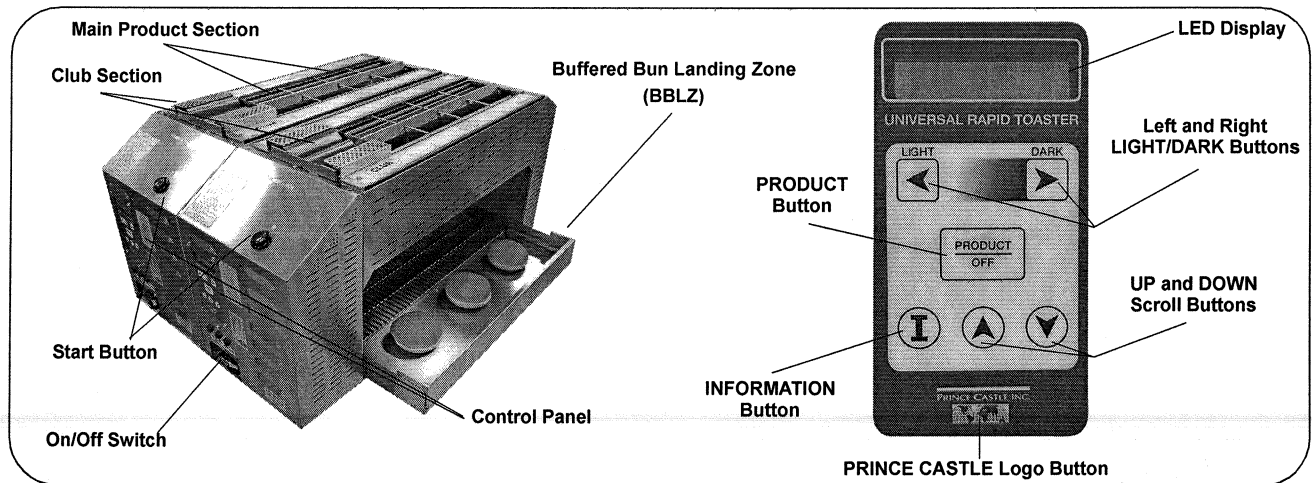

### LIMITED WARRANTY

This product is warranted to be free from defects in material and/or workmanship for a period of two (2) years from date of original installation, not to exceed 30 months from date of shipment from our factory or 240,000 cycles. Any part or component which proves to be faulty in material and/or workmanship within the warranty period will be replaced or repaired (at the option of Prince Castle, Inc.) without cost to the customer for parts or labor.

This warranty is subject to the following exceptions/conditions:

- Use of any non-genuine Prince Castle parts voids this warranty and all work must be performed by an authorized Prince Castle Service Agent.
- All labor shall be performed during regular work hours. Overtime premium will not be covered.
- Travel charges are limited to 100 miles (200 kilometers) round trip, 2 hours travel time, one trip per repair.
- Damage caused by carelessness, neglect, and/or abuse (e.g., using wrong current, dropping, tampering with or altering electrical components, or improper cleaning) is not covered.
- Equipment damaged in shipment, by fire, flood or an act of God is not covered.
- Damage to non-stick coated surfaces is not covered by this warranty.

### TABLE OF CONTENTS

Product Identification .....	1
Safety Information .....	2
Important .....	2
Installation .....	2
Installing New Riser and Rear Chute .....	5
Operation .....	6
Loading Diagram .....	8
Operation Tips .....	9
Adjustments/Settings .....	10
Management Programming .....	11
Troubleshooting .....	12
Exploded Views and Parts Lists .....	17
Wiring Diagram .....	21
Printed Circuit Board .....	22

### CAUTION

Only use URT Cleaning Tool with a sanitized towel or blue non-scratch pad wrapped around the head of the cleaning tool to clean the platens. Do NOT use anything abrasive because it will scratch the platens, which could cause bun sticking. Do not use abrasive materials such as scrapers, steel wool, etc. to clean the Buffered Bun Landing Zone or exterior of the unit, as damage to the surface could occur. Failure to follow the correct cleaning procedure or damage to the platen due to scratches are not covered under the provisions of the warranty.

Do NOT use any unapproved agents or cleaning solutions inside or on the surfaces of the toaster unit.

PRINCE CASTLE LLC  
WORLDWIDE

THE A. MESSON Group / Distributing Machinery Company

355 East Kehoe Blvd. • Carol Stream, IL 60188 USA  
Telephone: 630-462-8800 • Toll Free: 1-800-PCASTLE  
Fax: 630-462-1460 • www.princecastle.com

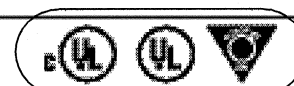

**Safety Information**

**⚠ WARNING**

Indicates information important to the proper operation of the unit. Failure to observe may result in damage to the equipment and/or severe bodily injury or death.

**⚠ CAUTION**

Indicates information important to the operation of the unit. Failure to observe may result in damage to the equipment.

**Important**

Prince Castle reserves the right to change specifications and product design without notice. Such revisions do not entitle the buyer to corresponding changes, improvements, additions or replacements for previously purchased equipment. This unit requires (2) 30 amp single phase outlets.

**Installation**

- 1** Remove the unit from the carton and inspect for signs of damage. If there is damage to the unit:
- Notify the carrier within 24 hours of delivery,
  - Save carton and packaging materials for inspection purposes,
  - Contact your local dealer, or if purchased directly, the Prince Castle Sales Department at 1-800-722-7853 or 630-462-8800 to arrange for a replacement unit.

- 2** *NOTE: When installing this unit, the ambient temperature at the mounting site should not exceed 37.8°C (100°F).*
- Your toaster consists of two units positioned together to perform as an assembly. Two-unit assemblies must be equipped with a BBLZ and a bun chute that carries the product from the rear unit to the BBLZ.

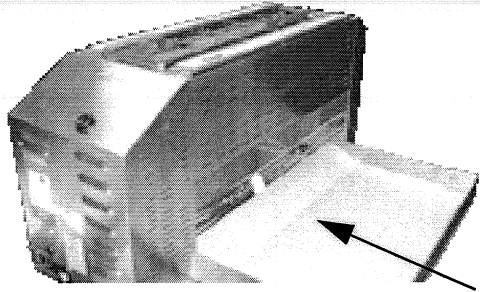
- 4** Slide the BBLZ into the front chamber of a two-unit assembly by pushing the BBLZ into the unit from the front towards the back.
- 

- 3** A. To install the 340-URT, designate one unit to be the "FRONT" chamber. The design is flexible to place the "CLUB TOASTING SLOT" either toward the primary or secondary side, depending on store management's preference. Another factor to consider is cord placement in the assembly line.
- B. *NOTE: This bracket is installed by Prince Castle for shipping purposes only.*

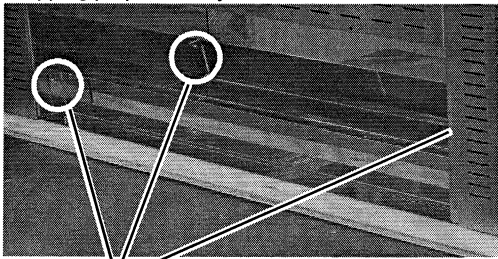

Screws

1. Remove two screws securing the shipping stiffener bracket.
2. Repeat step 1 for the other shipping stiffener.
3. Discard the two shipping stiffeners.

- 5** Push the BBLZ about halfway into position and connect the wire assembly from underneath the BBLZ to the connectors on the base of the unit and the BBLZ. This connection provides power to heat the BBLZ.

Wire Assembly Under BBLZ

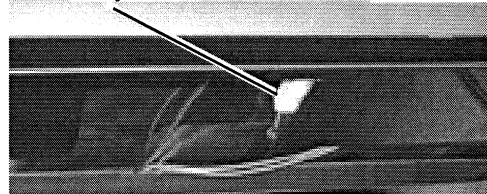

## Installation (continued)

6

- A. Push the BBLZ into position. The BBLZ is in the correct position when the mounting holes on the BBLZ align with the mounting holes on the toaster unit.
- B. Insert screws to hold BBLZ in position.
- C. Ensure all wiring is beneath the BBLZ and is not outside the toaster.

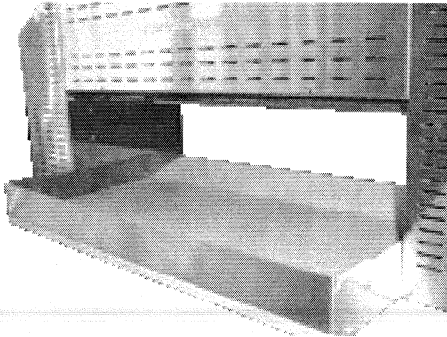

BBLZ Pushed Back into Position

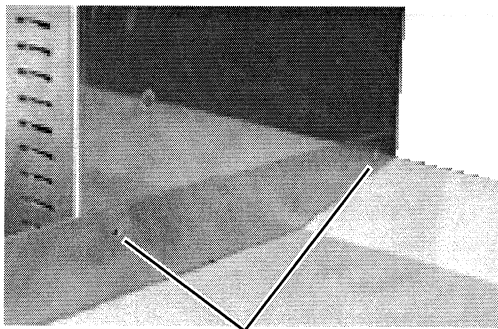

Mounting Holes Align

7

- A. On the "rear" chamber, push the bun chute into the toaster from the back toward the front, aligning the bun chute with the mounting holes on the back of the toaster unit.
- B. Insert 2 screws into the back of the unit to hold the bun chute into position.
- C. Insert 2 screws into the inside walls at the front of the chute.

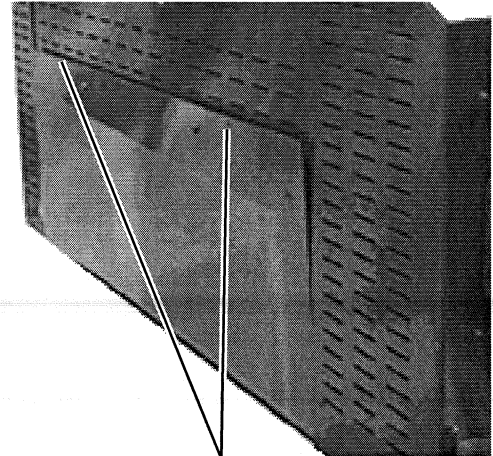

Rear Mounting Screws

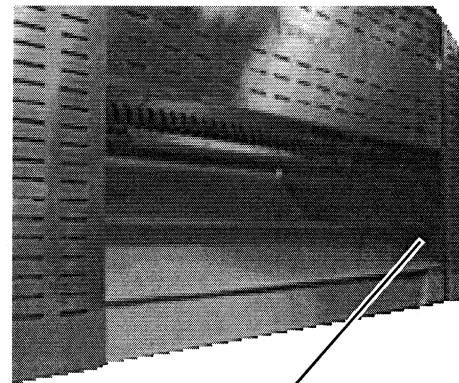

Front Mounting Screws

**Installation (continued)**

**8** To connect toaster units, push the rear toaster unit behind the front toaster unit, tilting the rear unit back and raising the bun chute of the rear unit slightly so that it slides over the BBLZ of the front unit.

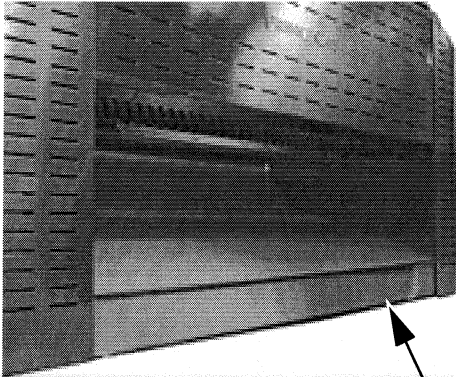

Tilt back the rear chamber so the front edge of the rear bun chute slides over the front chamber's BBLZ.

**10** Ensure all edges of the Wire Chute are inside the toaster and place on top of the BBLZ.

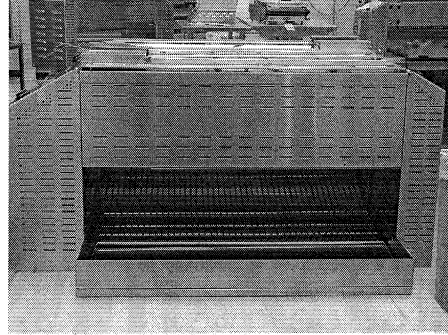

**11**

**CAUTION**

- All electrical connections must be in accordance with local electrical codes and any other applicable codes.
- A. Ensure that there are no wires or cords above the unit.
  - B. Plug the unit into an applicable electrical receptacle.

**9** Insert the Wire Chute, ensuring the large open area before the grid is facing the Crumb Release Bar.

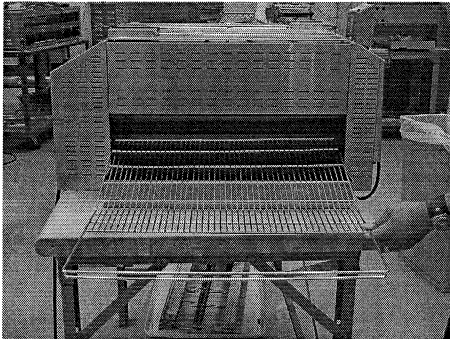

## Installing New Riser and Rear Chute

- 1** Remove the wire rack from the toasters and then move the rear toaster off the table. Next, place the larger riser piece, with the rubber mat facing down on the table, where the rear toasting chamber was.

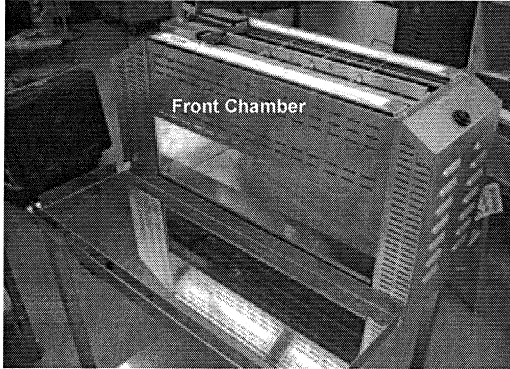

- 3** Remove the four screws (two at each side) at the bottom of the rear chamber. Set the rear chamber on the riser so the toaster sits inside all four flanges — see step 4.

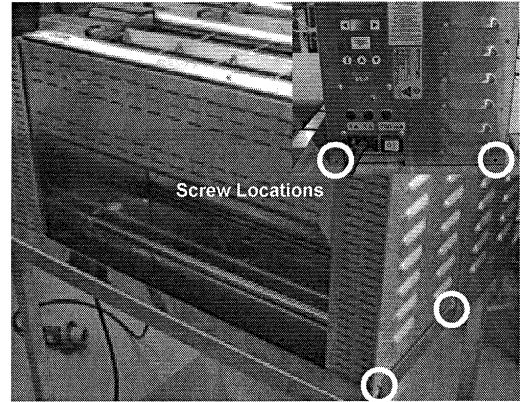

- 2** Place the smaller riser piece inside the larger piece so they sit flat on one another behind the front chamber.

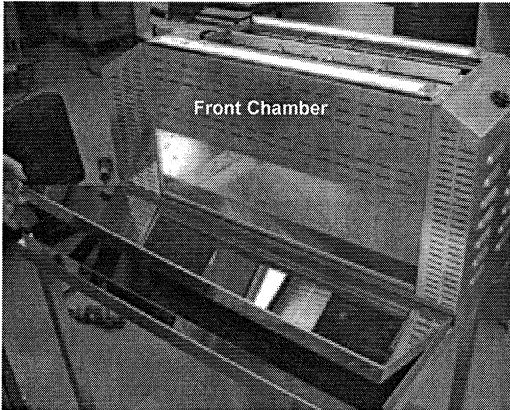

- 4** With the rear toasting chamber sitting inside the riser's flanges, insert the four screws at the bottom of the toaster to secure it to the riser base.

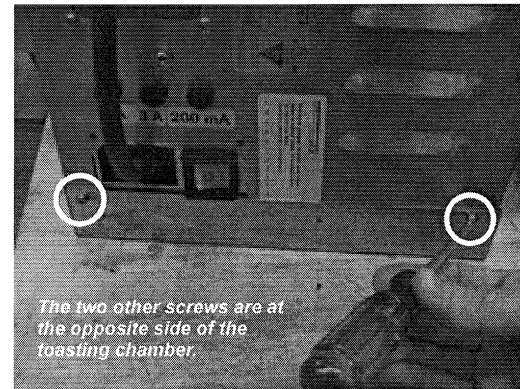



## Installing New Riser and Rear Chute (continued)

**5** Insert the NEW rear chute into the rear chamber, ensuring that the chute fits inside the riser's flanges.

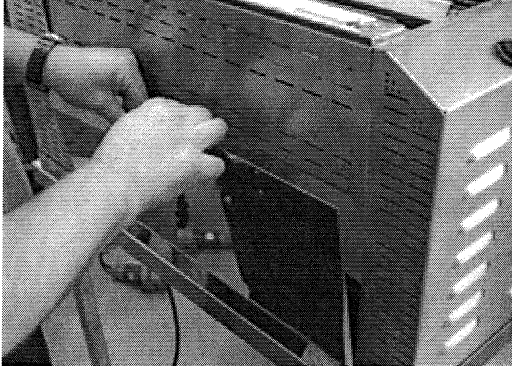

**6** Insert the two screws, connecting the chute to the toaster, and then re-insert the wire rack.

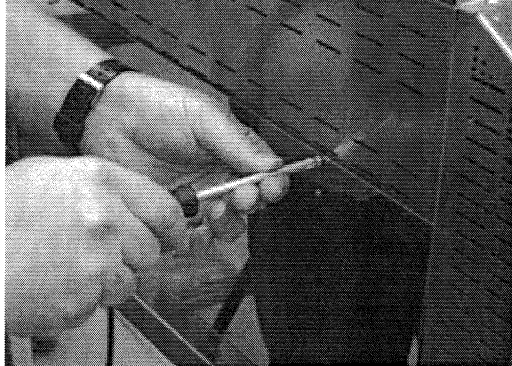

## Operation

Your Universal Rapid Toaster consists of two independent toasting chambers which, when positioned together, operate as one toaster. Each chamber has its own power switch and Control Panel.

- 1** A. Turn the On/Off switch(es) located below the control panel on the side of the unit(s) to ON. Display will read "wait" for approximately 10 seconds. After 20 seconds, the unit(s) will complete its internal setup, and the Control Panel screen will display OFF.  
B. Wait for warm-up. This should take 20 minutes for muffins or bagels and 25 minutes for buns.

**2**  **WARNING**

**BURN/ELECTRICAL SHOCK HAZARD!** Heating elements are HOT and can cause severe burns or severe shock! Keep hands and objects out of the toaster unit! Failure to exercise caution may result in serious injury! Turn the unit off, unplug it and let it cool down completely before touching or working on internal apparatus.

A. Use only the front toaster for Bagels.  
B. On the Control Panel, press the PRODUCT button to select the desired bread product (i.e., bagel, muffin, bun). The display shows the product selected.  
C. Wait for warm-up. This should take 20 minutes for muffins or bagels and 25 minutes for buns.

**WARM-UP TIMES**  
Cold Start to Breakfast – 20 minutes  
Cold Start to Buns – 25 minutes  
Breakfast to Buns – 15 minutes  
Buns to Breakfast – 20 minutes



## Operation (continued)

**3** **NOTE:** To cancel any operation in progress and release the bread product inside a chamber, press and hold the **START** button for 2 seconds, then release it to cycle the bun release doors. Gates will remain open while button is depressed.

- A. Begin by loading bread into the top of the unit (see Loading Diagram on Page 8).
- B. Press **START** button to toast the loaded product. The bread is toasted and discharged into the Buffered Bun Landing Zone (BBLZ).

**TIP:** During breakfast, place the UHC tray on the BBLZ, so that it is easier to load the product.

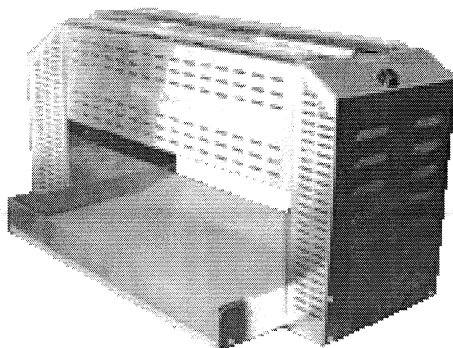

### BREAKFAST LOADING

Whether you are toasting bagels or muffins, the loading process is similar.

- A. Pre-split the breakfast product. This ensures that every bagel or muffin is toasted consistently.
- B. Load the product with the cut side facing the outside heaters (cut side-out).

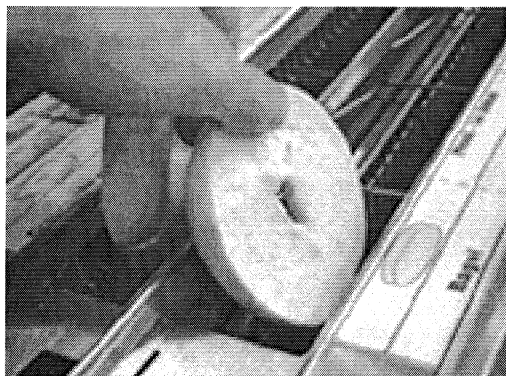

- C. Press **START** button to begin the toasting cycle.

### LUNCH LOADING

- A. The toaster can be easily loaded from either side of the prep table. Load the buns so that the cut-side makes contact with the grey platen (cut side-in). There is a separate slot for the club/flatbread section that allows toasting on both sides. Any combination of buns can be toasted at any time. Regular, Big Mac, Quarter, and Premium Chicken Roll all fit into any slot.
- B. Press **START** button to begin the toasting cycle.



**NOTE:** The walls may move out during the cycle. This is normal; it helps to retain the shape of the bun.

### BUZZ SOUND

A buzz is heard when product is caught in the release gate. It also may be heard at the end of the toast cycle. This sound is normal and the toaster is operating normally.

**4**

### CHANGEOVER

The URT needs 15 minutes for temperatures to stabilize at the new set points while transitioning from breakfast to lunch. Since most stores will be using two URT units locked together, one suggested procedure is:

- A. Toast additional product of the lower volume breakfast items and hold in UHC.
- B. Convert one toaster to buns at 10:15 AM, so that it is ready to toast buns for lunch. Keep the other toaster in its current breakfast mode, so you can continue to sell the higher volume sandwich.
- C. Convert the other toaster at 10:30 AM and then begin using it at 10:45 AM.

**NOTE:** There is no transition time going from **BAGEL** to **MUFFIN** or vice versa.

**Loading Diagram**

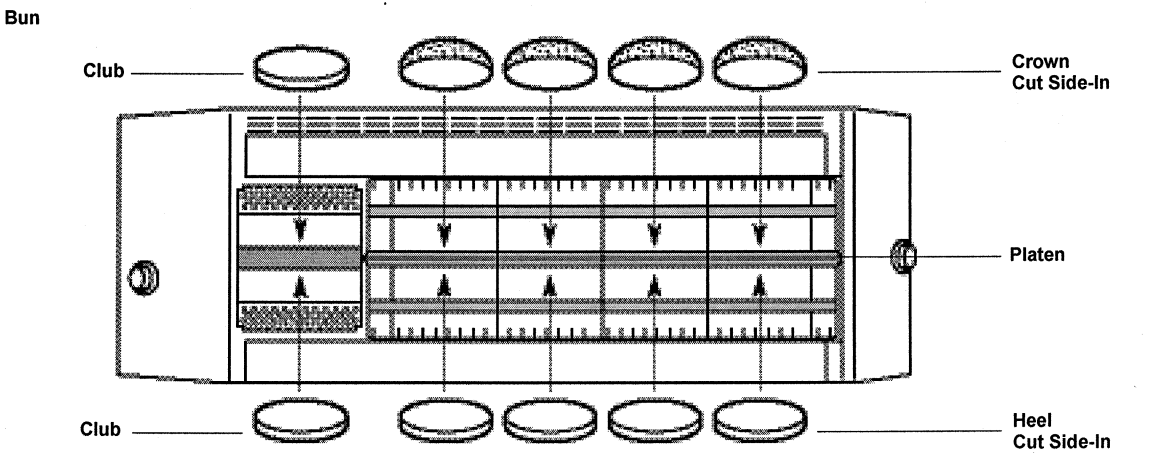
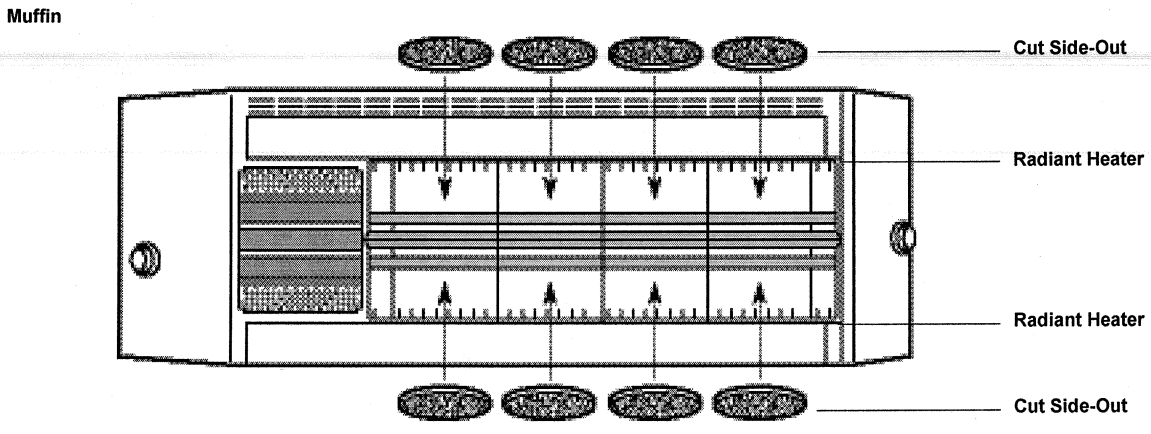
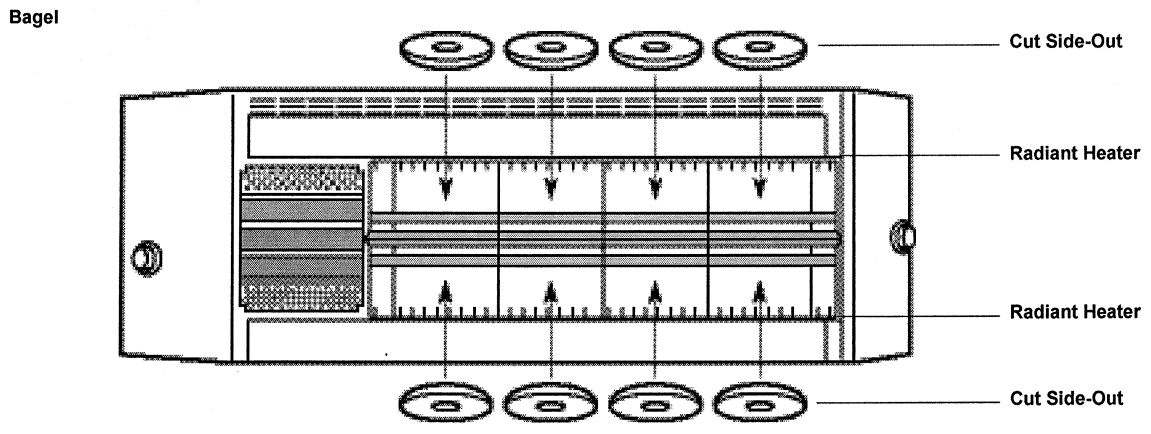



## Operation Tips

### BREAKFAST MENU

The toaster can be set up to optimize its use based on sales product mix.

#### Equal Bagel to Muffin Counts

- Set the rear toasting chamber to MUFFIN and the front chamber to BAGEL.
- 15 minutes before changeover, toast extra of the lower-demand product (usually bagels) and hold in UHC to last until breakfast ends.
  - Immediately after toasting, convert that toasting chamber to BUNS so that chamber is ready for lunch.
  - If you need more of the lower-demand product, simply switch to that product. There is no transition time between BAGEL and MUFFIN settings.

#### High Muffin Counts

- Set both sections to MUFFIN.
  - Place all the muffin heels (up to eight) in the front section and press the START button, then place the crowns in the back section and press the START button.
  - The heels will come out first so you can load the heels in two trays. When the crowns are discharged, then you can load those atop the heels.
- When Bagels are to be toasted, change one chamber to BAGEL and begin the toasting process.
- 15 minutes before changeover, convert one chamber to BUNS.

### REGULAR MENU

#### Bun Loading

Unlike other rapid toasters where buns can come out at different times, in the Prince Castle URT, all the buns come out at once. If you are preparing two sandwiches, you will not have to wait for the second bun to fall.

In addition, you never have to wait to load a bun. You can load up to eight buns at one time (when using a two-unit assembly).

When loading the toaster, you should consolidate multiple screens/orders so you can toast those buns in the same chamber, saving you more assembly time.

#### Bun Organization

The Prince Castle URT is naturally organized so that you can toast "in lanes." Use the two slots closest to the START button to toast Regular buns and the two slots furthest for Quarters. Then when buffering buns, these buns are already in their "buffering locations."

The buns are discharged as they are loaded into the toaster. For example, if you place the crowns on top and the heels on the bottom, they will land and sit on the BBLZ similarly.

#### TWO-UNIT ASSEMBLY TIPS

- During less busy times, you can turn off the rear chamber to save energy.
- Since you will naturally use one chamber more than another, swap the chambers (rear to front; front to rear) periodically to balance the cycles.
- Any combination of buns can be toasted at any time (1 regular, 1 Quarter, 1 Big Mac and 1 Premium Chicken Roll).

### Adjustments/Settings

Your Universal Rapid Toaster consists of one unit or an assembly of two units. Each unit has its own Control Panel and will be set up independently.

- 1 LIGHT/DARK Buttons**  
To adjust the settings for darker or lighter toasting, press the Left or Right LIGHT/DARK buttons (right and left arrows) on their respective Control Panel.  
*NOTE: The default setting for darkness is the middle setting.*

Left and Right LIGHT/DARK Buttons

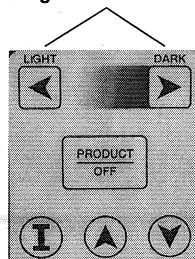

- 2 PRODUCT Button**  
Pressing the PRODUCT button selects the desired bread product to be toasted — bagel, muffin or bun. The LED Display shows the product selected.

PRODUCT Button

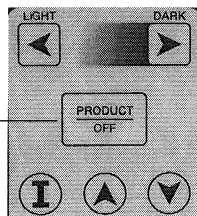

- 3 I (INFORMATION) Button and UP and DOWN Scroll Buttons**

While holding the INFORMATION button, press the UP and DOWN scroll buttons to view the settings and actual readings.

- Toast Power (operation capacity for radiant heaters)
  - ▼ Front Radiant — F-Rad
  - ▼ Front Club — F-Club
  - ▼ Platen
  - ▼ Rear Club — R-Club
  - ▼ Rear Radiant — R-Rad
- Toast Time (Cycle Count) for each bread product
  - ▼ Bagel Time (Count)
  - ▼ Muffin Time (Count)
  - ▼ Bun Time (Count)

To change these settings, see Programming.

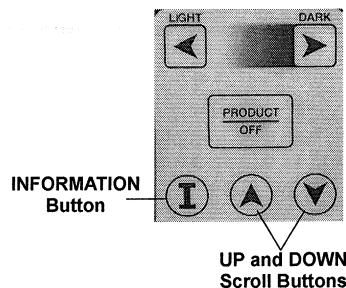

- 4 Factory Presets**  
*NOTE: All previously saved settings are lost upon resetting the defaults! Use with caution.*  
To reset all settings to manufacturer's defaults, turn the unit OFF. Then press and hold the PRINCE CASTLE Logo button together with the UP and DOWN buttons (all simultaneously) for 3 seconds while turning the unit back on.

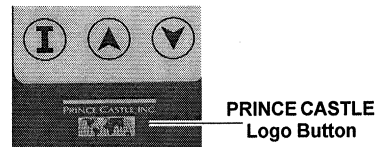

**Management Programming**

*NOTE: Improper adjustments can affect the operation of the unit. Do NOT attempt to adjust any unlisted settings without authorization from your management.  
Each bread product must be adjusted independently on each toasting chamber.*

**1** To enter the Program Mode, press and hold the PRINCE CASTLE Logo button for 6 seconds.  
*NOTE: During programming, press the PRINCE CASTLE Logo button at any time to move backward one step in the program.*

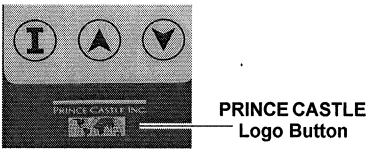

PRINCE CASTLE Logo Button

**2**

- Using the UP and DOWN scroll buttons, scroll through the main menu to find the bread product you want to change.
- Press the INFORMATION button to select the product.
- Use the UP and DOWN scroll buttons to scroll through the product's settings (e.g., Toast Time, Toast Power, etc.).
- Press the INFORMATION button to select the desired setting.
- Use the UP or DOWN arrow button to change the value of the product's setting.
- Press the "I" button to save the changes.
- Press the PRINCE CASTLE Logo button several times to exit the Program Mode.

*NOTE: For the recommended toast quality, change only the Toast Time settings. For minor adjustments to the toast quality, use the LIGHT/DARK buttons.*

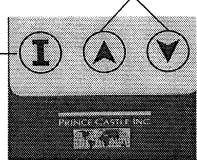

INFORMATION Button

UP and DOWN Scroll Buttons

Factory Presets 5.07	Buns	Muffins	Bagels
<b>1st Level Programming:</b>			
Time	17	90	50
Toast Power	N/A	75%	85%
Idle Power	N/A	55%	70%
Platen Temp (°F)	550	N/A	N/A
Club Temp (°F)	530	N/A	N/A
Compression	30	N/A	N/A

New Settings	Buns	Muffins	Bagels
<b>1st Level Programming:</b>			
Time			
Toast Power			
Idle Power			
Platen Temp (°F)			
Club Temp (°F)			
Compression			

**Troubleshooting**

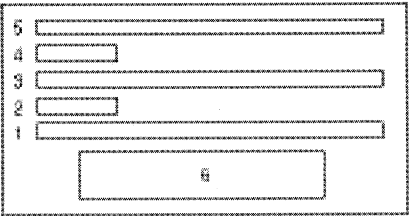

**Toaster may be hot!**

SYMPTOM	POSSIBLE CAUSE	CHECK	REMEDY
Bagels or muffins are not toasted or toasted product is not dark enough.	Toaster settings are incorrect.	<ol style="list-style-type: none"> <li>Increase toast time.</li> <li>Increase toast temperature for both radiant heaters. (Temperature increased by increasing power to heaters in increments of 5%.)</li> </ol>	Change both toast time and temperature until an appropriate combination is reached.
	Heater or relay is not functioning.	<ol style="list-style-type: none"> <li>Turn power off and allow the toaster to cool.</li> <li>Carefully remove the side panels in order to view the heater relays.</li> <li>Turn unit ON and immediately press and hold the PRINCE CASTLE Logo button, the INFORMATION button, and the PRODUCT button. Hold these buttons until the display reads: "Heater Test".</li> <li>Press the INFORMATION button.</li> <li>The LED on relay 1 should begin blinking and corresponding heater should begin to heat. Verify that heat is being generated by the heater.</li> <li>Press the down arrow to move to relay 2 and heater 2. Verify that the relay is operating. The display will read the current temperature for this heater. Verify that heat is being generated by the heater and that the display temperature increases by at least 5 degrees. Press the down arrow to move to the next relay and heater.</li> </ol> <p><i>NOTE: Heaters 1 and 5 are IR heaters and do not have a temperature probe. Therefore, the display will not show a temperature setting for these heaters, only for 2, 3, 4 and 6. It is for front chute heater and will only be displayed if the front chute is connected and working.</i></p> <ol style="list-style-type: none"> <li>Repeat each of these steps for the remaining relays and heaters.</li> </ol> <p>Heater configuration is:</p> 	<ol style="list-style-type: none"> <li>If relay LEDs do not light up, verify that relay is receiving voltage from main PCB. If it is receiving voltage, replace relay.</li> <li>Verify that relay is sending voltage to heater. When LED is on, voltage across the output terminals should be minimal. When LED is not on, voltage should be approximately 208V.</li> <li>If heater is receiving voltage, but does not generate heat, replace heater.</li> </ol>
	Main PCB is failing.	Check output voltage from main PCB to relay. When unit is heating, the voltage should be 5 VDC.	If there is no voltage output when unit should be heating, replace main PCB.

**Troubleshooting (continued)**

SYMPTOM	POSSIBLE CAUSE	CHECK	REMEDY
Bagels or muffins are too dark or burnt.	Toaster settings are incorrect.	<ol style="list-style-type: none"> <li>1. Reduce toast temperature of both radiant heaters. (Temperature is decreased by decreasing power to heaters in increments of 5%.)</li> <li>2. Reduce toast time.</li> </ol>	Change both toast time and temperature until an appropriate combination is reached.
	Relay is shorted.	Remove side panel to view relay. When the unit is not calling for heat, the LED on the relay should not be lit. Measure the voltage across the output terminals of the relay. When the LED is not lit, the voltage should be approximately 208V. When the LED is lit, the voltage should be less than 2.	Replace relay.
	Main PCB is failing.	Measure the voltage output at the relay connection at the main PCB. When the unit is not calling for heat, there should be no output voltage. When the unit is calling for heat, the output voltage is 5 VDC.	Replace main PCB.

**Troubleshooting (continued)**

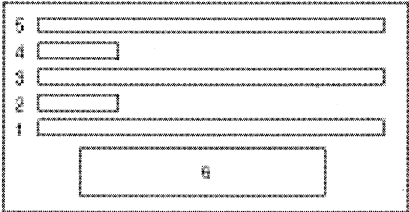
SYMPTOM	POSSIBLE CAUSE	CHECK	REMEDY
Buns are not toasted or product is not dark enough.	Toaster settings are incorrect.	1. Check heater temperature. 2. Change compression settings. If both crowns and heels are light, increase compression setting (the higher the compression setting, the greater the compression).	
	Heater or relay is not functioning.	1. Turn power off and allow the toaster to cool. 2. Carefully remove the side panels in order to view the heater relays. 3. Turn unit ON and immediately press and hold the PRINCE CASTLE Logo button, the INFORMATION button, and the PRODUCT button. Hold these buttons until the display reads: "Heater Test". 4. Press the INFORMATION button. 5. The LED on relay 1 should begin blinking and corresponding heater should begin to heat. Verify that heat is being generated by the heater. 6. Press the down arrow to move relay 2 and heater 2. Verify that the relay is operating correctly. The display will read the current temperature for this heater. Verify that heat is generated by the heater and that the display temperature increases by at least 5 degrees. Press the down arrow to move to the next relay and heater. <i>NOTE: Heaters 1 and 5 are IR heaters and do not have a temperature probe. Therefore, the display will not show a temperature setting for these heaters, only for 2, 3, 4 and 6.</i> 7. Repeat each of these steps for the remaining relays and heaters. Heater configuration is: 	1. If relay LEDs do not light up, verify that relay is receiving voltage from main PCB. If it is receiving voltage, replace relay. 2. Verify that relay is sending voltage to heater. When LED is on, voltage across the output terminals should be minimal. When LED is not on, voltage should be approximately 208V. 3. If heater is receiving voltage, but does not generate heat, replace heater.



### Troubleshooting (continued)

SYMPTOM	POSSIBLE CAUSE	CHECK	REMEDY
Buns are not toasted or product is not dark enough (continued).	Main PCB is failing.	Measure the voltage output at the relay connection at the main PCB. When the unit is not calling for heat, there should be no output voltage. When the unit is calling for heat, the output voltage is 5 VDC.	Replace main PCB.
	Faulty temperature probe.	Measure the resistance reading of the RTD. At room temperature, the RTD should read approximately 1090 $\Omega$ $\pm$ 2%	Replace temperature probe.
Buns are too dark of product is burnt.	Toaster settings are incorrect.	<ol style="list-style-type: none"> <li>1. Check heater temperature.</li> <li>2. Change compression settings. If both crowns and heels are dark, decrease compression setting (the higher the compression setting, the greater the compression).</li> <li>3. If only one side is dark, adjust the compression wall by removing the cotter pin and removing washers to move the wall to the appropriate position. Replace cotter pin.</li> </ol>	
	Faulty temperature probe.	Measure the resistance reading of the RTD. At room temperature, the RTD should read approximately 1090 $\Omega$ $\pm$ 2%.	Replace temperature probe.
	Relay is shorted.	Remove side panel to view relays. When the unit is not calling for heat, the LED on the relay should not be lit. Measure the voltage across the output terminals of the relay. When the LED is not lit, the voltage should be approximately 208V. When the LED is lit, the voltage should be less than 2.	Replace relay.
	Main PCB is failing.	Measure the voltage output at the relay connection at the main PCB. When the unit is not calling for heat, there should be no output voltage. When the unit is calling for heat, the output voltage is 5 VDC.	Replace main PCB.
Gates are stuck open or closed.	Rocker plate is stuck.	Carefully remove side panel and inspect rocker plate.	<ol style="list-style-type: none"> <li>1. Reposition rocker plate.</li> <li>2. Apply lubricant to plate.</li> </ol>
	Solenoid failed.	Take resistance reading of the solenoid. The solenoid should have a resistance reading of more than 5 $\Omega$ .	Replace solenoid.
	Main PCB is failing.	Measure voltage output to the solenoid from the PCB. When solenoid is actuated, the voltage should be approximately 208V.	Replace main PCB.
Compression walls do not open wide enough.	Wall position set incorrectly.	In programming mode, change the RESTPOS setting to a higher number to increase the distance between the walls.	

**Troubleshooting (continued)**

SYMPTOM	POSSIBLE CAUSE	CHECK	REMEDY
Compression plates do not move or do not move to the correct position.	Compression setting is incorrect.	Ask store to verify that the compression setting is correct.	
	Encoder is set improperly or has failed.	Home position: 1. Press product button until BUN appears in display. 2. Press and hold the PRINCE CASTLE Logo button until the display reads "Program Mode". 3. Press the DOWN arrow until "Exit Program" appears. 4. Press both the RIGHT and LEFT arrows at the same time. The display will change to "Set Home" position. 5. Use a 1/2" (.500) spacer and place it 1" inside the heel opening. <i>NOTE: Be careful not to scratch platen. Spacer is included with this toaster. It is located under the motor mounting bracket.</i> 6. Using the UP and DOWN arrows, adjust the compression plate to make the spacer snug (not tight or loose) between the compression plate and the platen. 7. Press the INFORMATION button to save the new home position of the compression plate. 8. Press the PRINCE CASTLE Logo button to exit. <i>NOTE: This needs to be done after the Main PCB, Motor or Motor PCB are replaced.</i>	If encoder cannot be reset to the home position, replace the encoder.  If replacing the encoder fails to solve the problem, replace the PCB.
	Faulty power PCB.	If both the motor and the encoder are in working order, replace the power PCB.	
	Faulty main PCB.	If motor, encoder and power PCB are functioning properly, replace the main PCB.	
Key pad does not respond.	Faulty switch PCB.		Replace switch PCB.
START button does not activate toaster.	Faulty switch assembly.		Replace START button.
No display.	Faulty display or main PCB.		Replace main PCB.

**Exploded View and Parts List**

**Rear Parts Breakdown**

No.	Part No.	Description
1	78-240S	Start SW
2	85-125S	Solenoid
6	89-1060S	Collar 1/4" w/Set Screw (Pkg of 8)
7	340-296S	BKT, Pivot RH & LH Rear
8	340-296S	BKT, Pivot RH & LH Rear

No.	Part No.	Description
9	340-142S	Coupler Assy (Pkg of 2, includes 10)
10	197-279S	Gear Pin (Pkg of 8)
	340-299S	BKT, Pivot LH & RH Front *

\* Not shown.

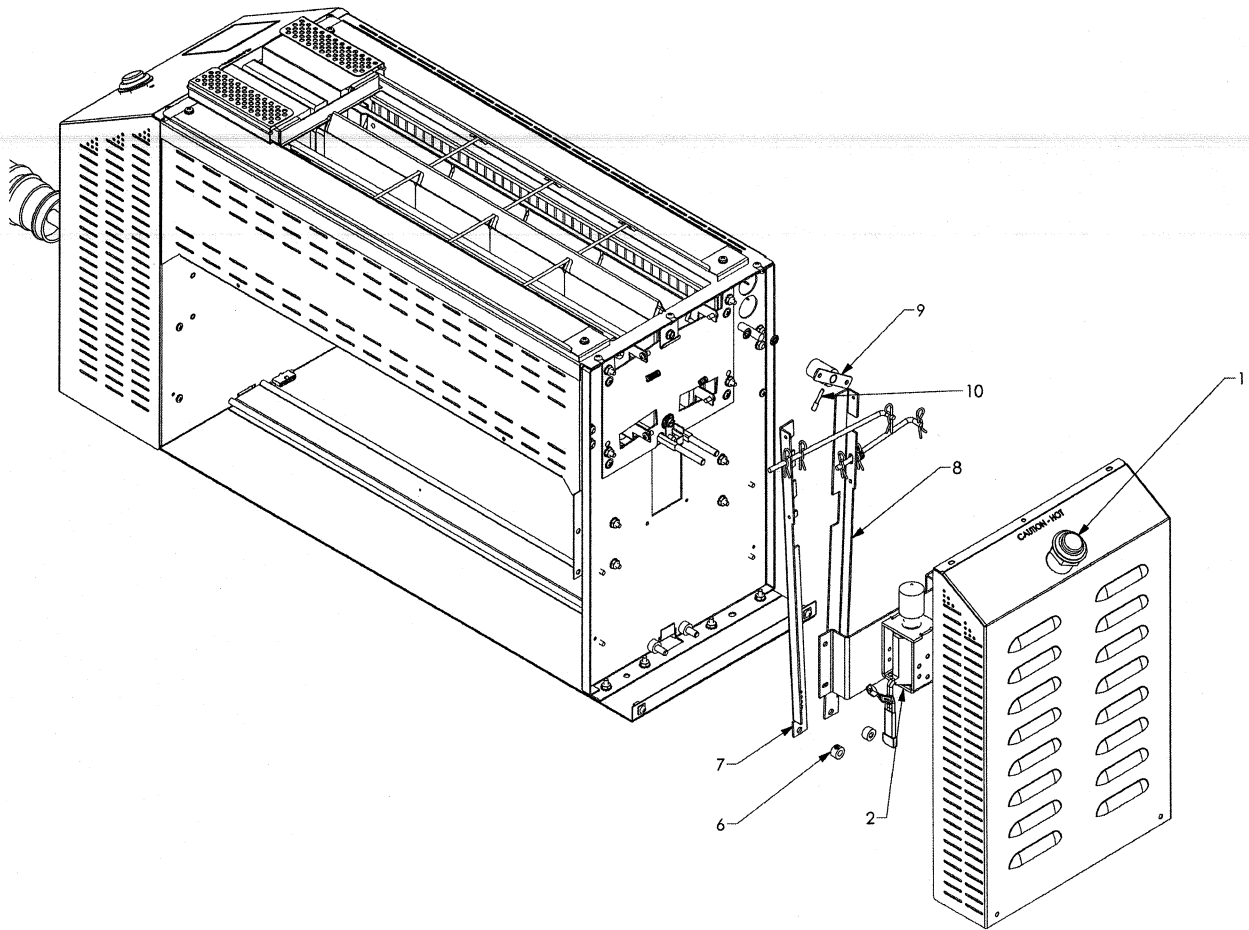

**Exploded View and Parts List**

**Controller Side Parts Breakdown**

No.	Part No.	Description
1	78-240S	Start SW
2	88-787S	Fuse Holder (Pkg of 12)
3	340-375S	Main PCB
4	340-358S	VFD Display Assy
5	78-241S	Power Switch
6	66-045S	Strain Relief
7	65-062-08S	SS Relay, DPDT, 30 amp, 24V DC

No.	Part No.	Description
8	65-063-06S	SS Relay, DPST, 30 amp, 200/240 AC, 50/60
9	77-059S	Terminal Block
10	340-682S	Motor & Encoder w/Drive
11	65-058S	Relay, SS, 50 amp 208V AC
	72-422S	Power Cord *
	88-600-200S	2 amp 250V (Pkg. of 10) *
	88-600-3000S	3 amp 250V (Pkg. of 10) *
	340-299S	BKT, Pivot LH & RH Front *

\* Not shown.

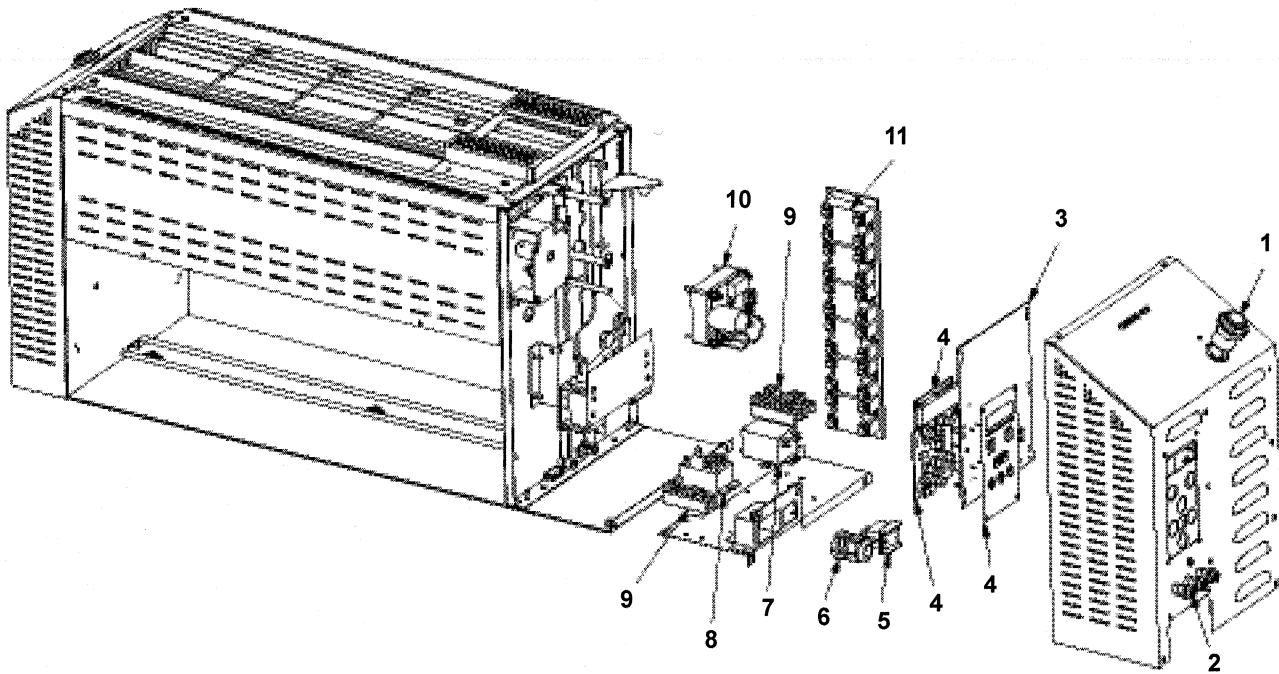

**Exploded View and Parts List**

**Parts Breakdown**

No.	Part No.	Description
1	340-368S	IR Heater (Right)
2	340-360S	Gate Kit
3	340-275S	Club Platen
4	340-269S	Main Platen
5	340-275S	Club Platen

No.	Part No.	Description
6	340-369S	IR Heater (Left)
7	340-236S	Club Divider
8	340-255S	Overlay (Heel & Crown)
9	340-451S	Side Panel
	340-242S	Main Probe *

\* Not shown.

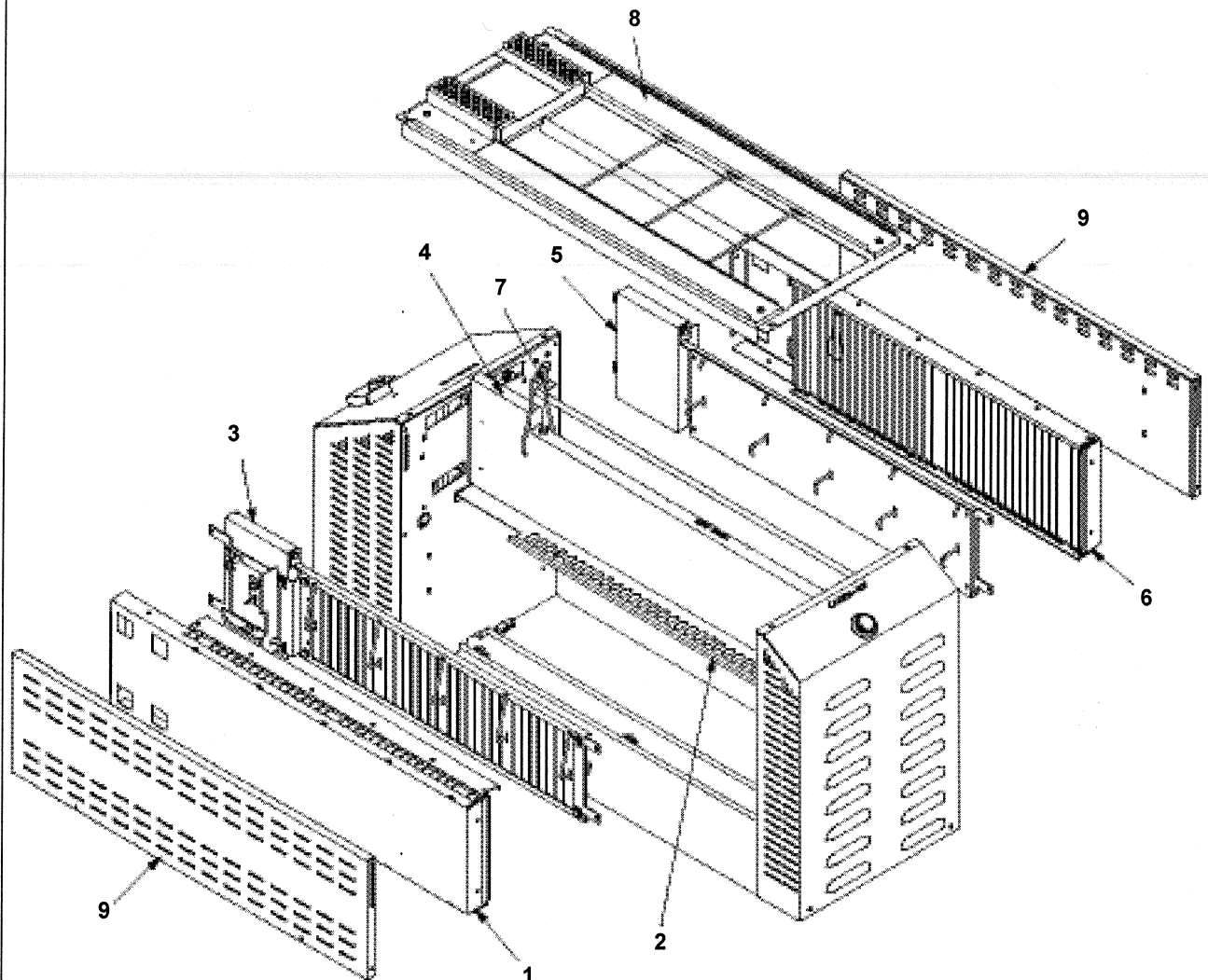

**Exploded View and Parts List**

**Parts Breakdown**

No.	Part No.	Description
1	89-1093S	Cotter Pin (Pkg of 4)
2	89-1064S	Compression Spring (Pkg of 2)
3	340-652S	Rod, Crush Link, Long

No.	Part No.	Description
4	340-651S	Rod, Crush Link, Short
5	340-142S	Coupler Assy w/Pin
	89-1063S	Retaining Ring & Small Cotter Pin (Pkg of 2) *

\* Not shown.

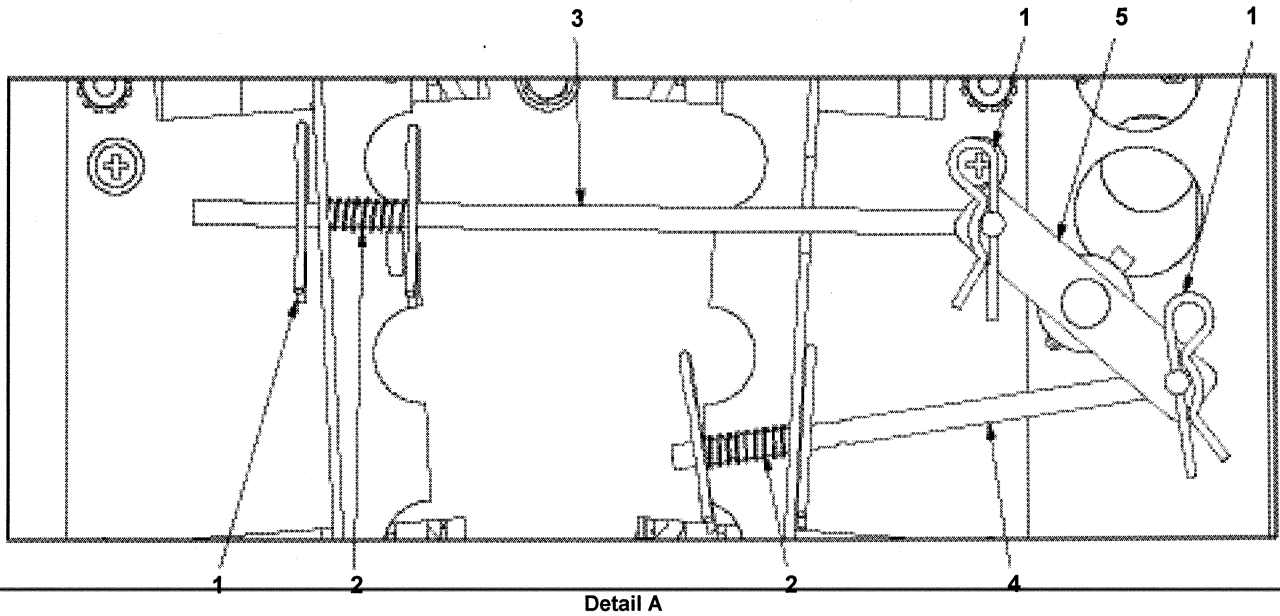
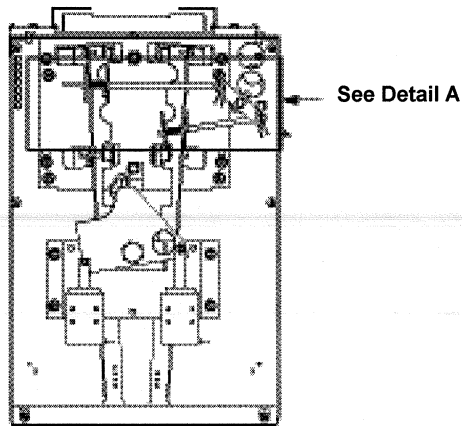



Wiring Diagram

